

HAMBURG

DIMENSION

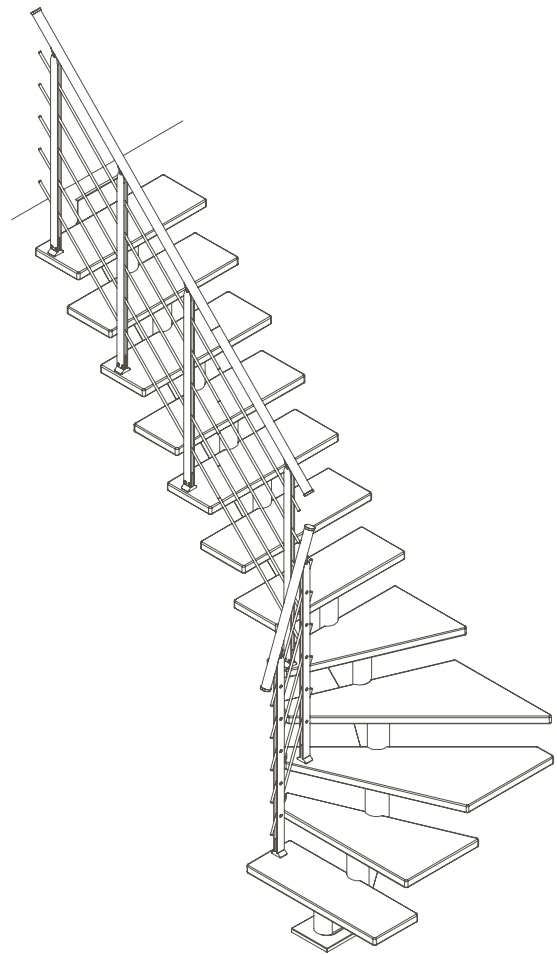
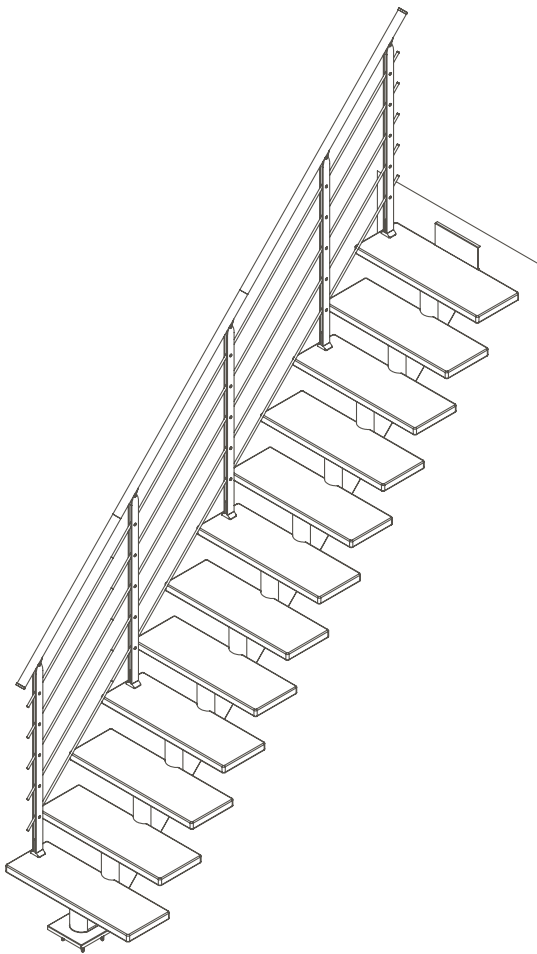
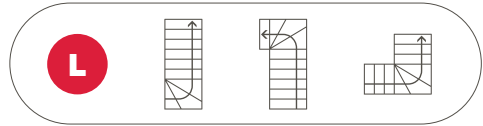
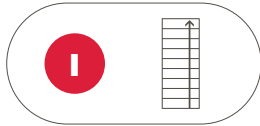

 Video: www.dolle.com/hamburg

Width 75 cm

NO. OF TREADS	PAGE
11 treads	7
12 treads	9
13 treads	11
14 treads	15

Width 85 cm

NO. OF TREADS	PAGE
11 treads	19
12 treads	21
13 treads	23
14 treads	27

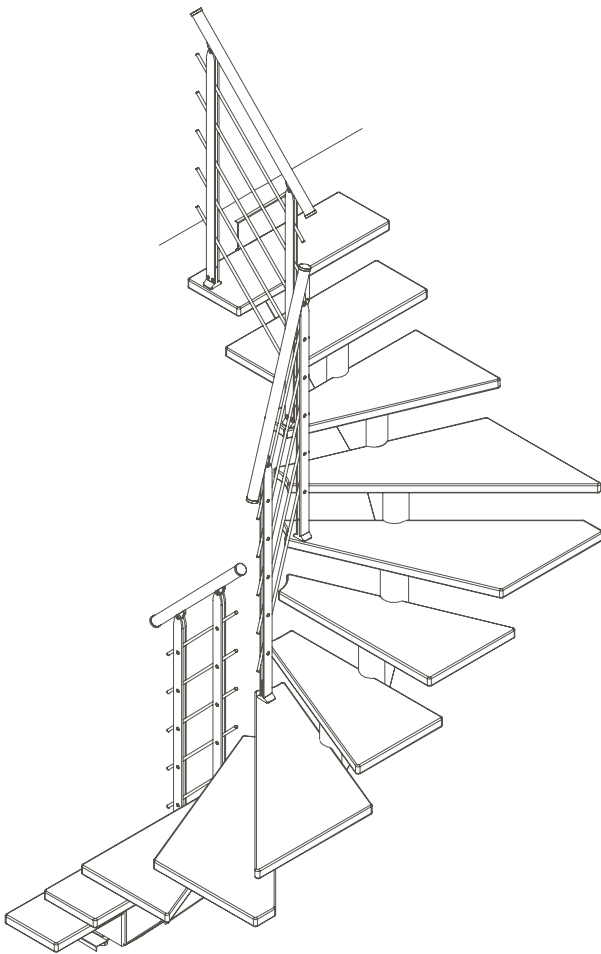
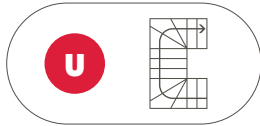

 Video: www.dolle.com/hamburg

Width 75 cm

NO. OF TREADS	PAGE
11 treads	7
12 treads	9
13 treads	11
14 treads	15

Width 85 cm

NO. OF TREADS	PAGE
11 treads	19
12 treads	21
13 treads	23
14 treads	27

STAIRCASE TERMINOLOGY

C1

E

G

H

M

	Staircase width w. 1 banister	Headroom	Going (of tread)	Height floor-to-floor	Upper floor opening length - min.
	Escalier à 1 rampe	Echappée	Giron	Hauteur sol-sol	Longueur de trémie min.
	Trappe bredde m. 1 gelænder	Frihøjde	Grund	Etagehøjde	Hulmål længde min.
	Trappbredd med 1 räcke	Frihöjd	Grund	Golv till golv höjd	Hålmått längd min.
	Treppenbreite inkl. 1 Geländer	Kopffreiheit	Auftrittsbreite	Geschosshöhe	Öffnungsgröße länge min.





N

O

P

R

R1

	Upper floor opening width - min.	Clear width	Pitch	Total going length	Total going width
	Largeur de trémie min.	Largeur de passage	Pente de l'escalier	Recul total - longueur	Recul total - largeur
	Hulmål bredde min.	Fri bredde	Stjghed/hældning	Udladning længde	Udladning bredde
	Hålmått bredd min.	Fri bredd	Hällning	Trapplängd	Trappbredd
	Öffnungsgröße breite min.	Durchgangsmaß	Winkel	Ausladung länge	Ausladung breite

S

T

V

W

X

	Rise height	Number of treads	Tread depth	Tread width	Tread thickness
	Hauteur de marche	Nombre de marches	Profondeur de marche	Largeur de marche	Epaisseur de marche
	Stigningshøjde	Antal trin	Trin dybde	Trin bredde	Trin tykkelse
	Steghöjd	Antal steg	Stegdjup	Stegbredd	Stegjocklek
	Steigungshöhe	Anzahl Stufen	Stufen tiefe	Stufen breite	Stufen Stärke

Z

	Deck thickness
	Epaisseur de dalle
	Dæk tykkelse
	Bjälklagstjocklek
	Deckenstärke

DIMENSIONS

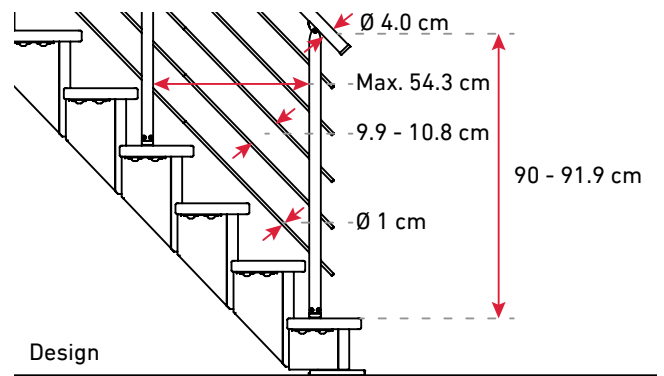
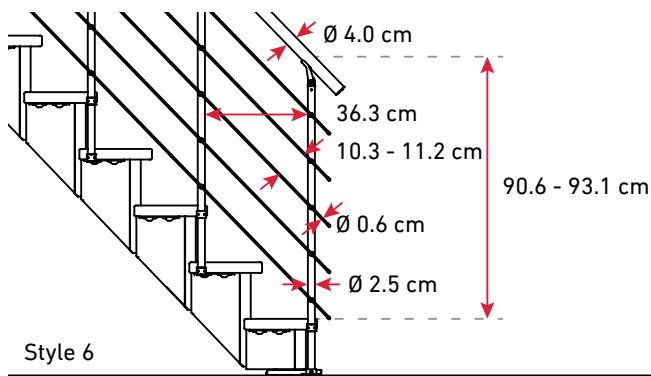
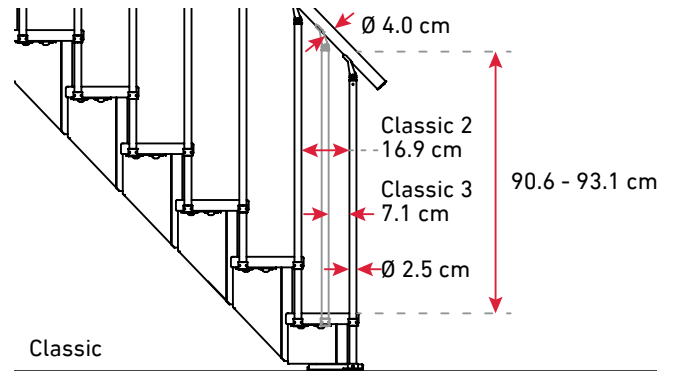
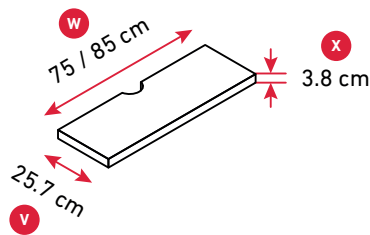
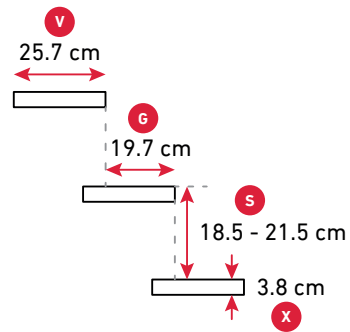
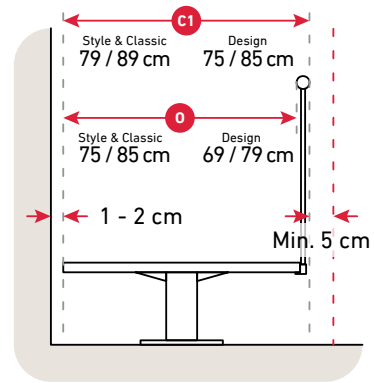
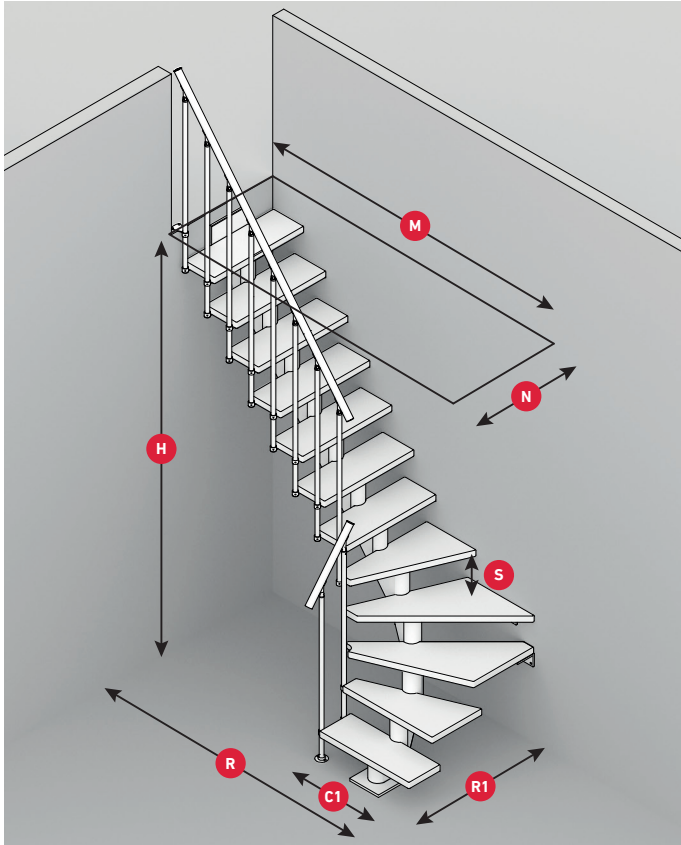

DIMENSIONS

- H** (14T) 277.5 - 322.5 cm
- (13T) 259 - 301 cm
- (12T) 240.5 - 279.5 cm
- (11T) 222 - 258 cm
- (10T) 203.5 - 236.5 cm
- (9T) 185 - 215 cm

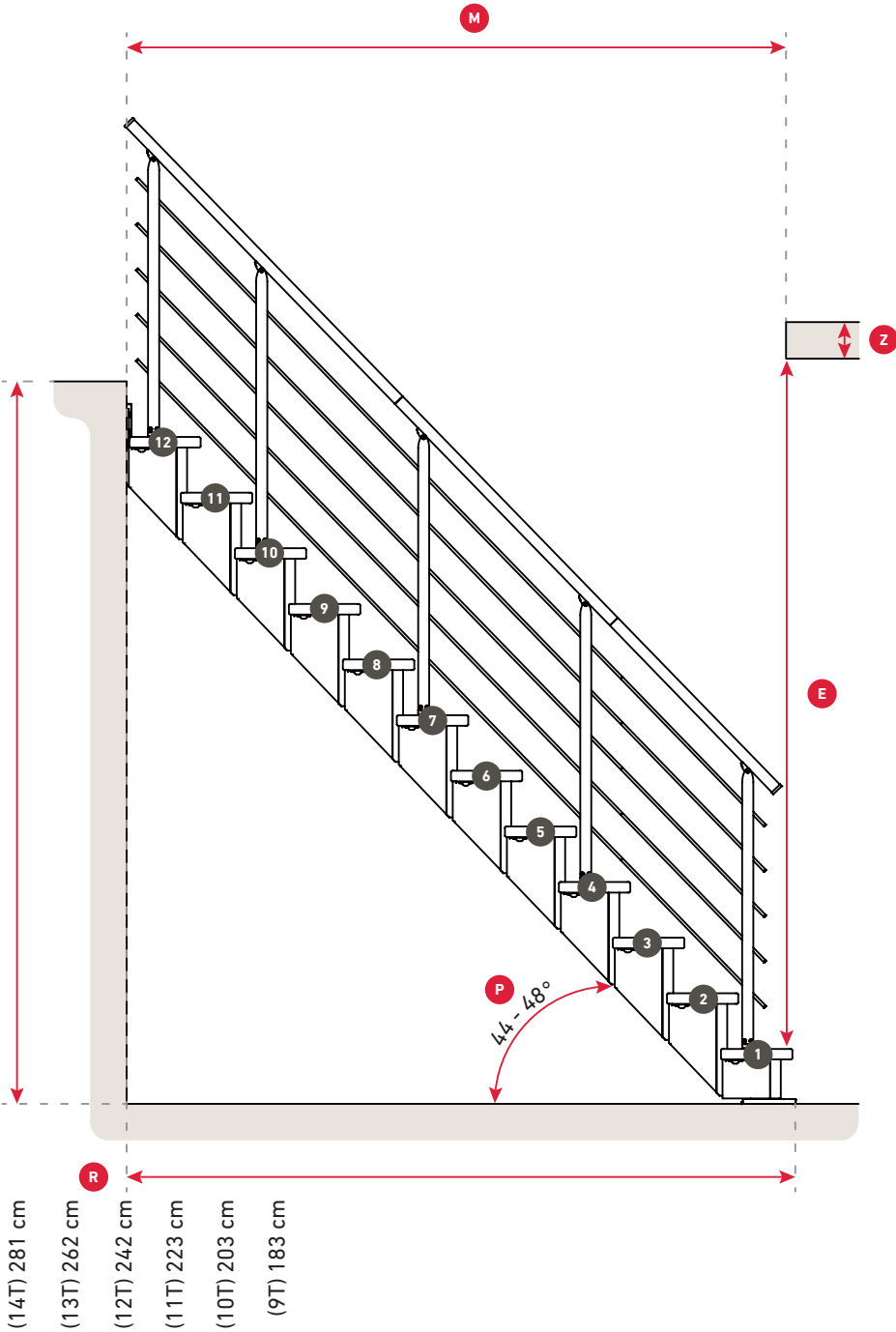

HAMBURG 11 TREADS - WIDTH 75 CM

H 222 - 258 cm

— Staircase dimensions incl. Classic/Style 6 banister on 1 side. See p. 5 for staircase width (C1) with Design banister.

- - Floor opening size is defined based on 2 cm space to wall, 5 cm space for hand, 19 cm rise height, 25 cm deck thickness, 200 cm headspace.

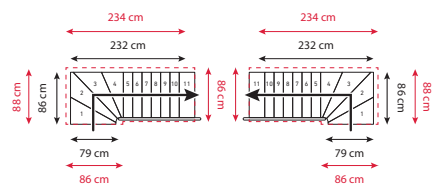
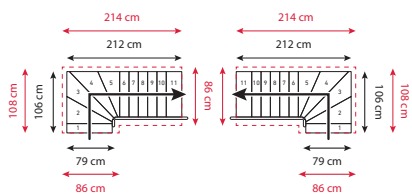
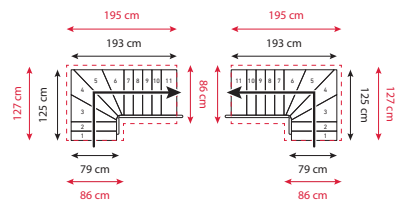
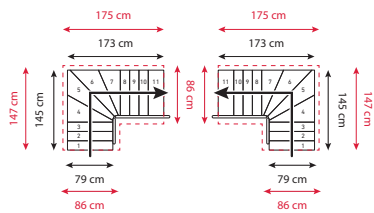
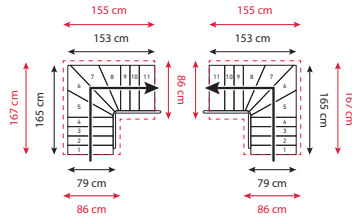
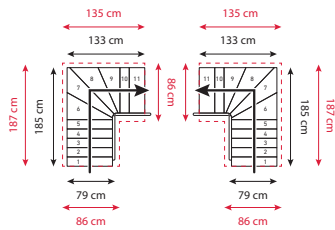
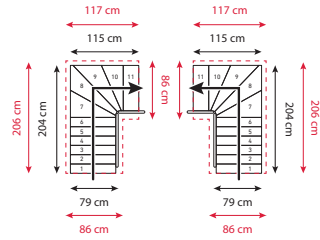
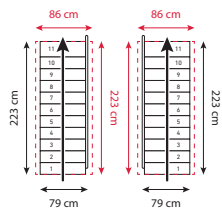

HAMBURG 11 TREADS - WIDTH 75 CM

H 222 - 258 cm

— Staircase dimensions incl. Classic/Style 6 banister on 1 side. See p. 5 for staircase width (C1) with Design banister.

- - - Floor opening size is defined based on 2 cm space to wall, 5 cm space for hand, 19 cm rise height, 25 cm deck thickness, 200 cm headspace.

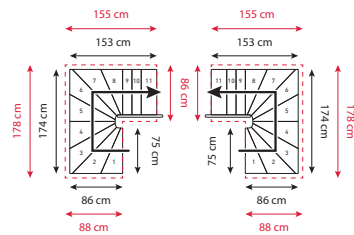
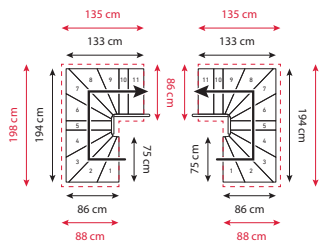
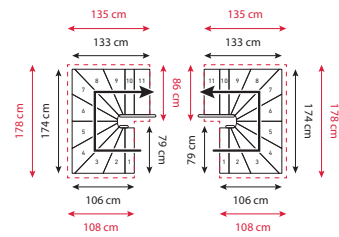
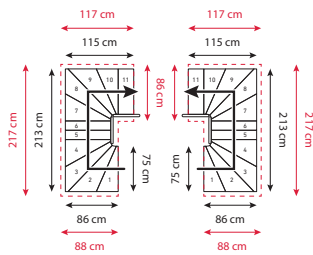
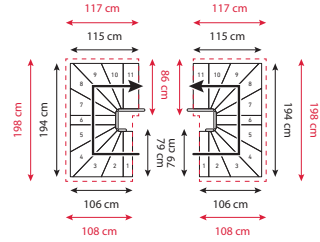
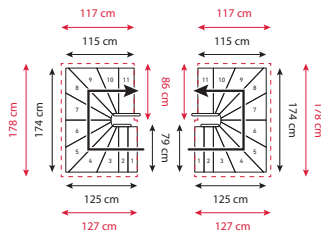

HAMBURG 12 TREADS - WIDTH 75 CM

H 240.5 - 279.5 cm

— Staircase dimensions incl. Classic/Style 6 banister on 1 side. See p. 5 for staircase width (C1) with Design banister.

- - Floor opening size is defined based on 2 cm space to wall, 5 cm space for hand, 19 cm rise height, 25 cm deck thickness, 200 cm headspace.

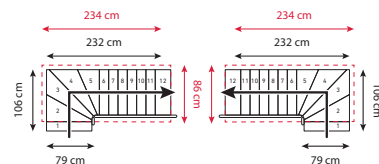
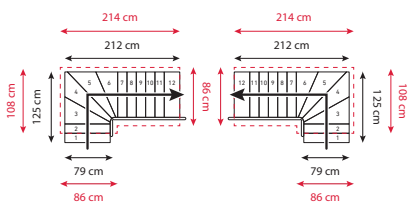
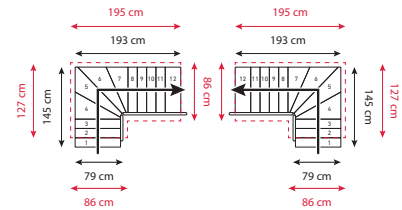
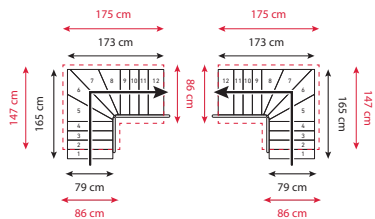
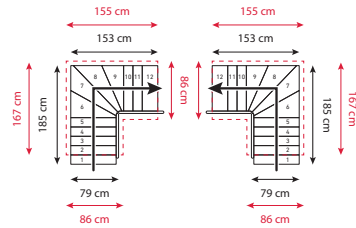
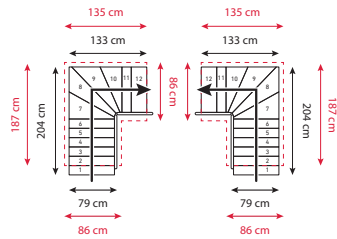
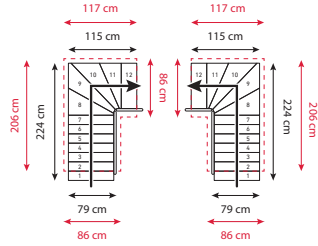
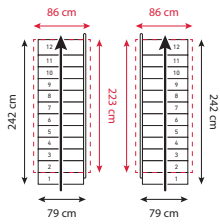

HAMBURG 12 TREADS - WIDTH 75 CM

H 240.5 - 279.5 cm

— Staircase dimensions incl. Classic/Style 6 banister on 1 side. See p. 5 for staircase width (C1) with Design banister.

--- Floor opening size is defined based on 2 cm space to wall, 5 cm space for hand, 19 cm rise height, 25 cm deck thickness, 200 cm headspace.

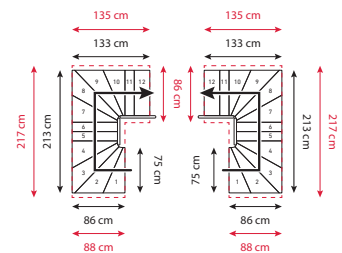
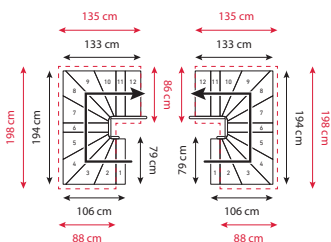
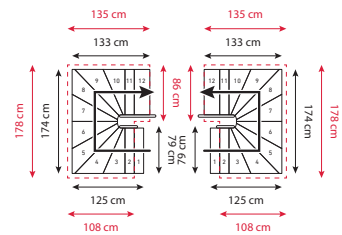
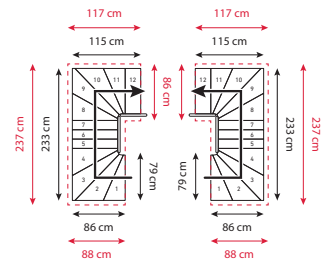
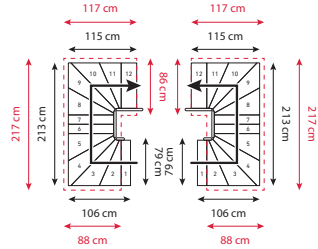
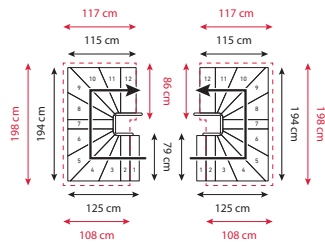
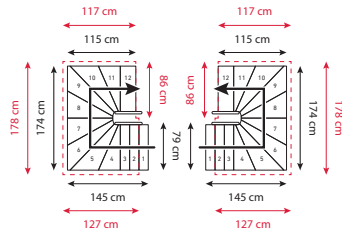
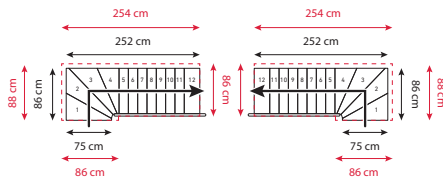

HAMBURG 12 TREADS - WIDTH 75 CM

H 240.5 - 279.5 cm

— Staircase dimensions incl. Classic/Style 6 banister on 1 side. See p. 5 for staircase width (C1) with Design banister.

- - Floor opening size is defined based on 2 cm space to wall, 5 cm space for hand, 19 cm rise height, 25 cm deck thickness, 200 cm headspace.

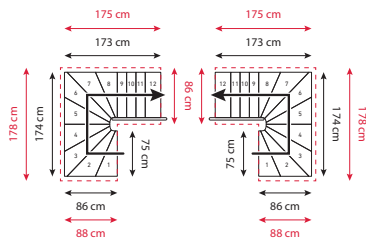
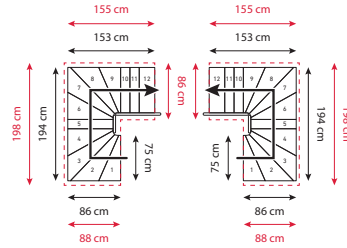
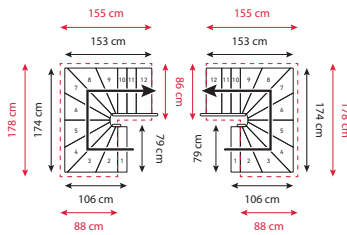

HAMBURG 13 TREADS - WIDTH 75 CM

H 259 - 301 cm

— Staircase dimensions incl. Classic/Style 6 banister on 1 side. See p. 5 for staircase width (C1) with Design banister.

- - Floor opening size is defined based on 2 cm space to wall, 5 cm space for hand, 19 cm rise height, 25 cm deck thickness, 200 cm headspace.

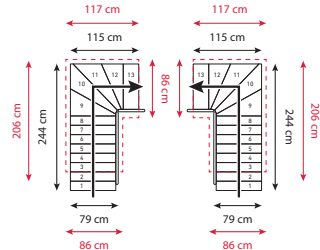
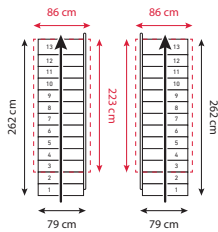

HAMBURG 13 TREADS - WIDTH 75 CM

H 259 - 301 cm

— Staircase dimensions incl. Classic/Style 6 banister on 1 side. See p. 5 for staircase width (C1) with Design banister.

- - - Floor opening size is defined based on 2 cm space to wall, 5 cm space for hand, 19 cm rise height, 25 cm deck thickness, 200 cm headspace.



HAMBURG 13 TREADS - WIDTH 75 CM

H 259 - 301 cm

— Staircase dimensions incl. Classic/Style 6 banister on 1 side. See p. 5 for staircase width (C1) with Design banister.

- - - Floor opening size is defined based on 2 cm space to wall, 5 cm space for hand, 19 cm rise height, 25 cm deck thickness, 200 cm headspace.

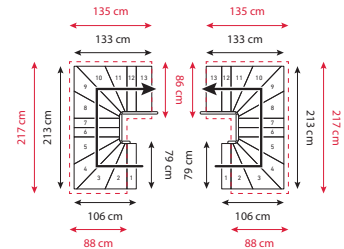
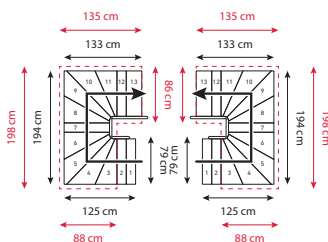
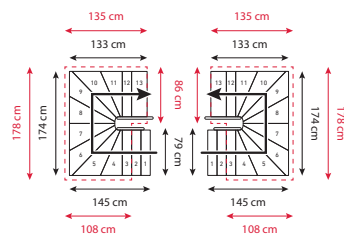
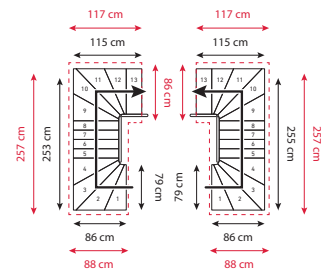
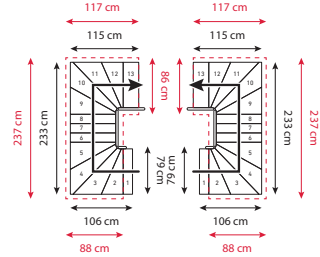
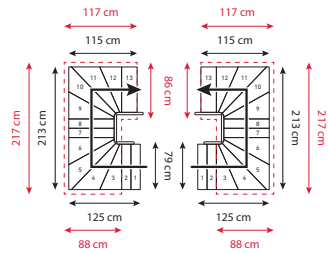
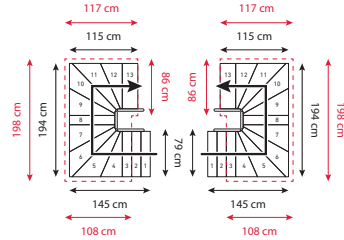
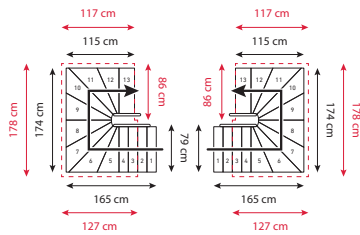

HAMBURG 13 TREADS - WIDTH 75 CM

H 259 - 301 cm

— Staircase dimensions incl. Classic/Style 6 banister on 1 side. See p. 5 for staircase width (C1) with Design banister.

- - Floor opening size is defined based on 2 cm space to wall, 5 cm space for hand, 19 cm rise height, 25 cm deck thickness, 200 cm headspace.

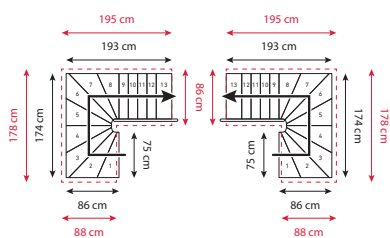
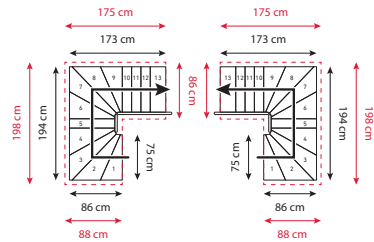
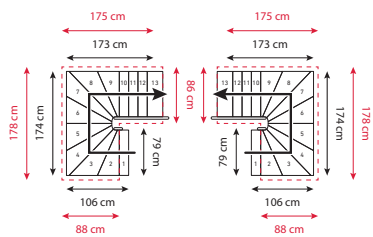
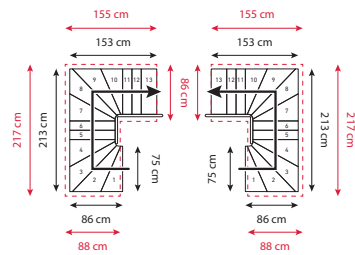
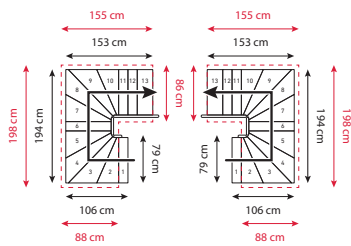
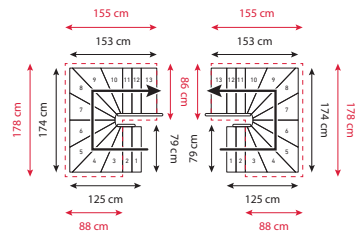
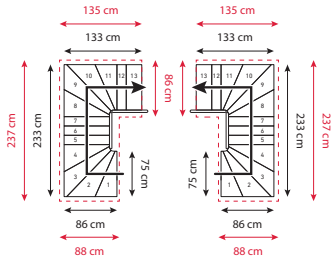

HAMBURG 14 TREADS - WIDTH 75 CM

H 277.5 - 322.5 cm

— Staircase dimensions incl. Classic/Style 6 banister on 1 side. See p. 5 for staircase width (C1) with Design banister.

- - Floor opening size is defined based on 2 cm space to wall, 5 cm space for hand, 19 cm rise height, 25 cm deck thickness, 200 cm headspace.

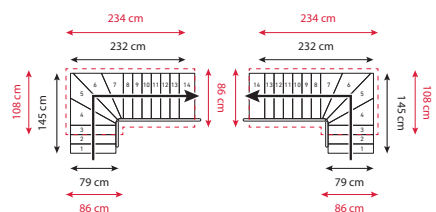
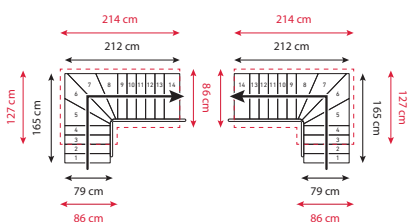
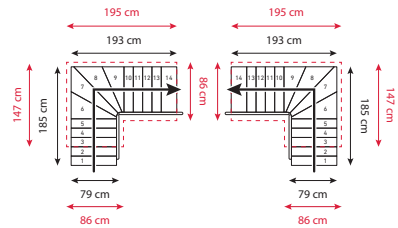
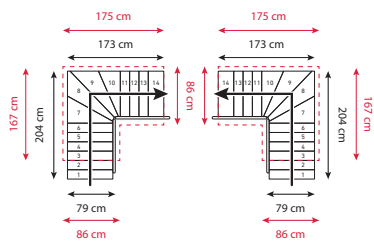
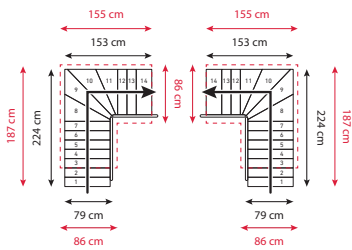
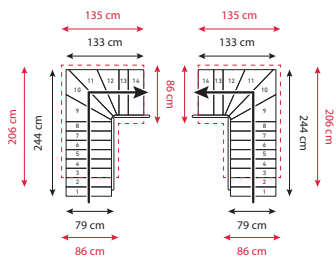
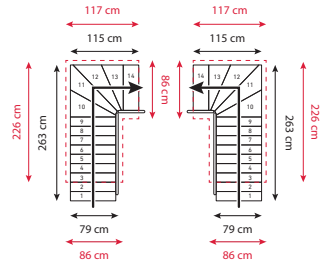
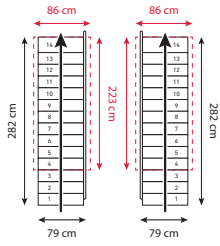

HAMBURG 14 TREADS - WIDTH 75 CM

H 277.5 - 322.5 cm

— Staircase dimensions incl. Classic/Style 6 banister on 1 side. See p. 5 for staircase width (C1) with Design banister.

- - Floor opening size is defined based on 2 cm space to wall, 5 cm space for hand, 19 cm rise height, 25 cm deck thickness, 200 cm headspace.

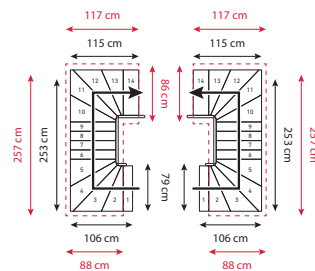
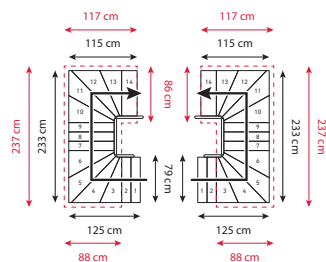
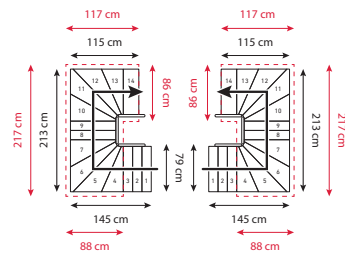
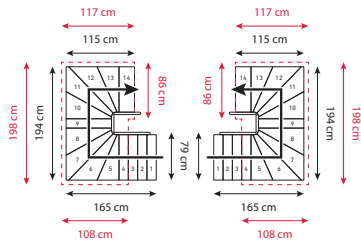
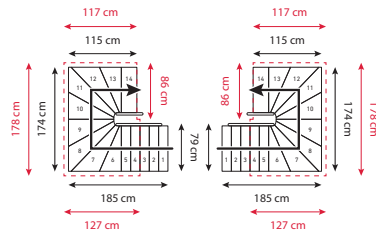
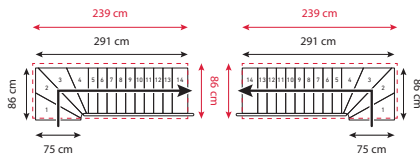
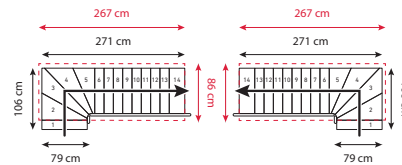
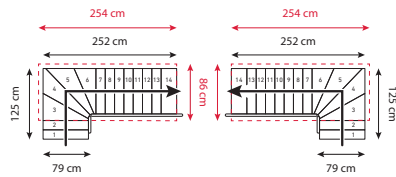

HAMBURG 14 TREADS - WIDTH 75 CM

H 277.5 - 322.5 cm

— Staircase dimensions incl. Classic/Style 6 banister on 1 side. See p. 5 for staircase width (C1) with Design banister.

--- Floor opening size is defined based on 2 cm space to wall, 5 cm space for hand, 19 cm rise height, 25 cm deck thickness, 200 cm headspace.

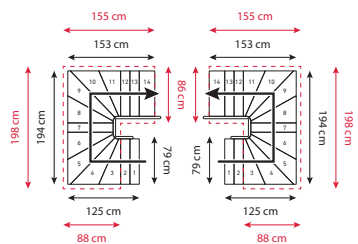
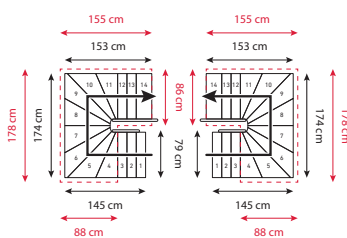
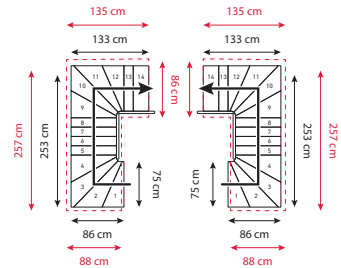
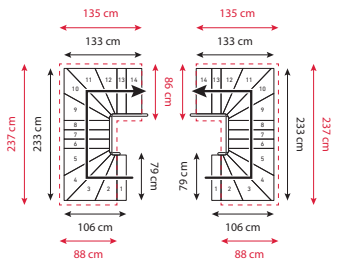
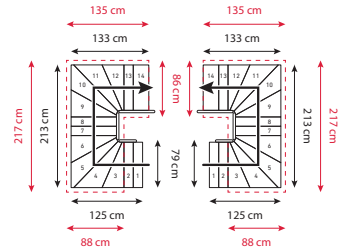
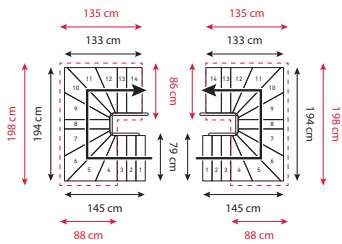
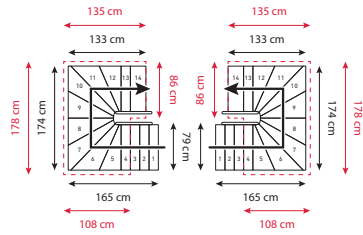
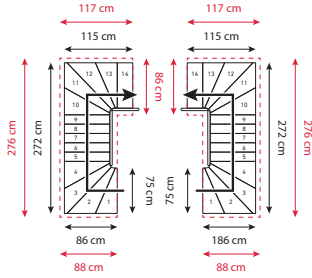

HAMBURG 14 TREADS - WIDTH 75 CM

H 277.5 - 322.5 cm

— Staircase dimensions incl. Classic/Style 6 banister on 1 side. See p. 5 for staircase width (C1) with Design banister.

--- Floor opening size is defined based on 2 cm space to wall, 5 cm space for hand, 19 cm rise height, 25 cm deck thickness, 200 cm headspace.

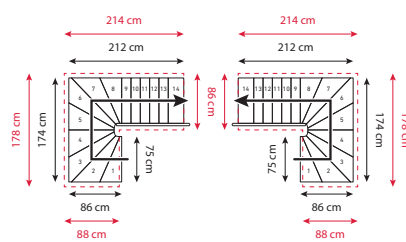
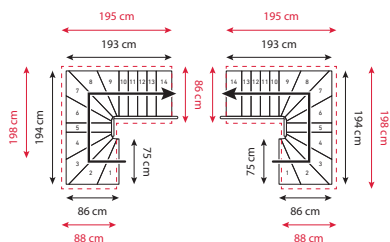
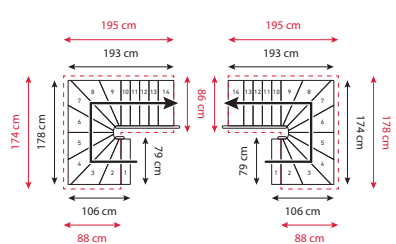
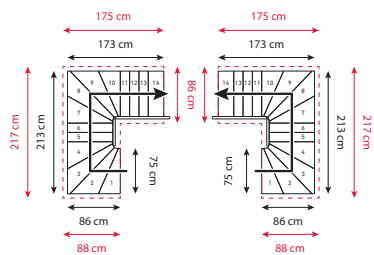
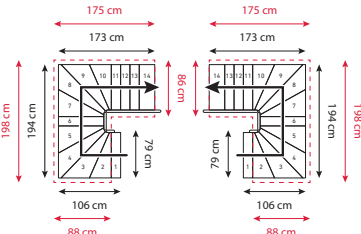
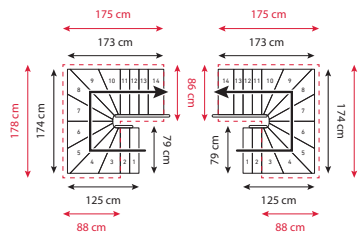
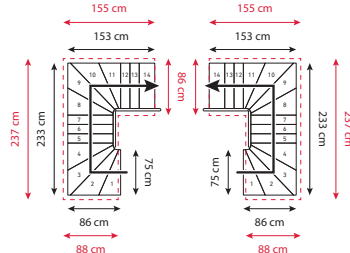
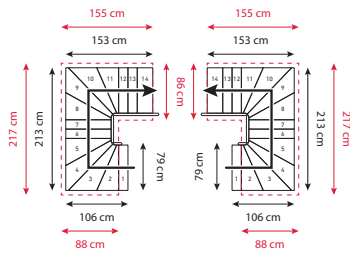

HAMBURG 11 TREADS - WIDTH 85 CM

H 222 - 258 cm

— Staircase dimensions incl. Classic/Style 6 banister on 1 side. See p. 5 for staircase width (C1) with Design banister.

- - - Floor opening size is defined based on 2 cm space to wall, 5 cm space for hand, 19 cm rise height, 25 cm deck thickness, 200 cm headspace.

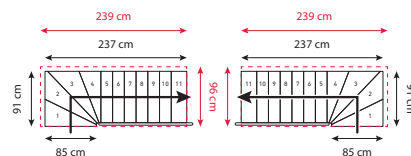
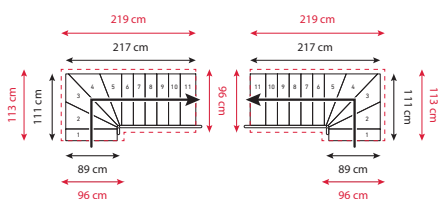
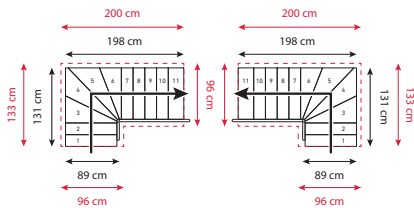
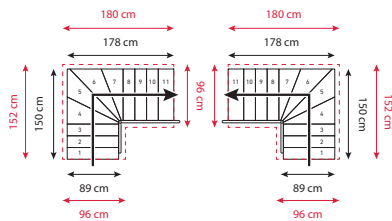
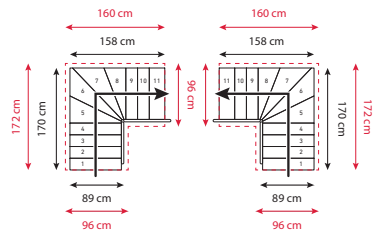
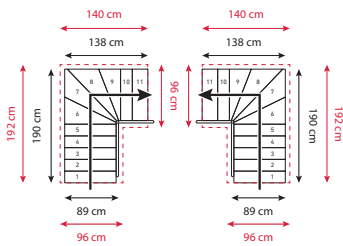
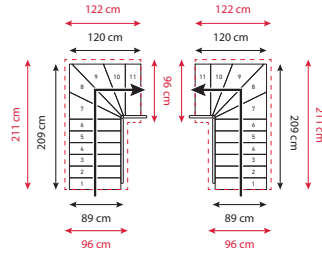
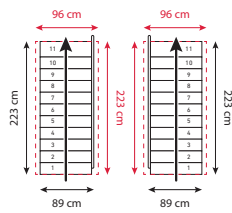

HAMBURG 11 TREADS - WIDTH 85 CM

H 222 - 258 cm

— Staircase dimensions incl. Classic/Style 6 banister on 1 side. See p. 5 for staircase width (C1) with Design banister.

- - - Floor opening size is defined based on 2 cm space to wall, 5 cm space for hand, 19 cm rise height, 25 cm deck thickness, 200 cm headspace.

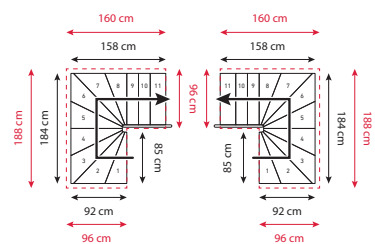
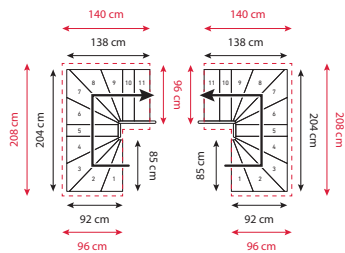
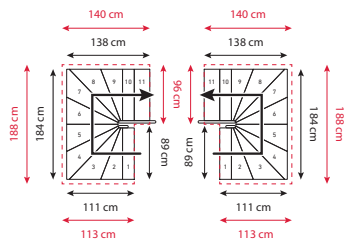
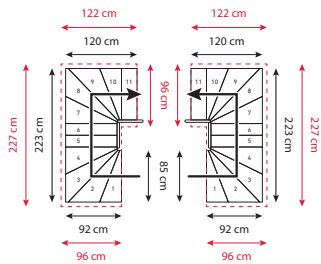
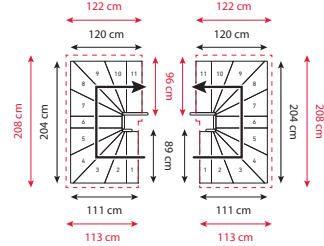
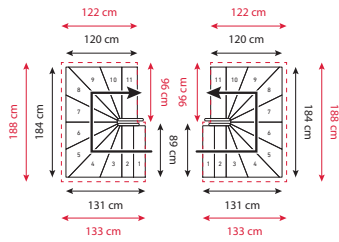

HAMBURG 12 TREADS - WIDTH 85 CM

H 240.5 - 279.5 cm

— Staircase dimensions incl. Classic/Style 6 banister on 1 side. See p. 5 for staircase width (C1) with Design banister.

--- Floor opening size is defined based on 2 cm space to wall, 5 cm space for hand, 19 cm rise height, 25 cm deck thickness, 200 cm headspace.

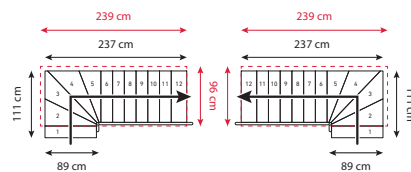
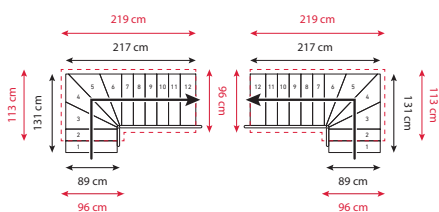
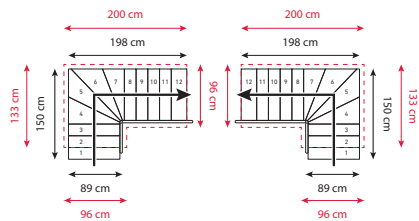
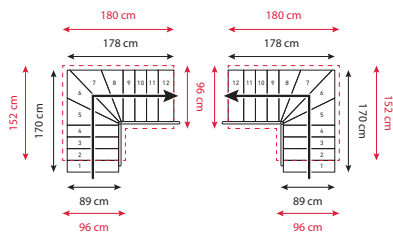
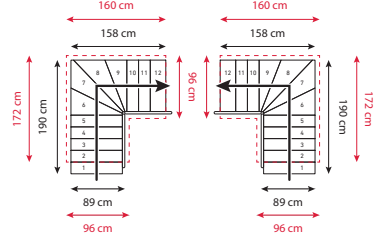
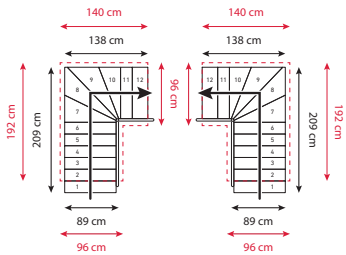
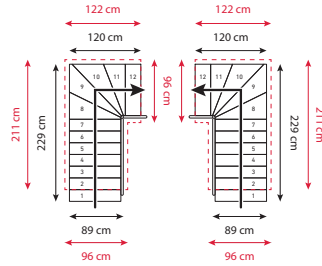
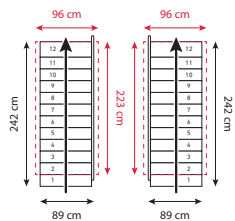

HAMBURG 12 TREADS - WIDTH 85 CM

H 240.5 - 279.5 cm

— Staircase dimensions incl. Classic/Style 6 banister on 1 side. See p. 5 for staircase width (C1) with Design banister.

--- Floor opening size is defined based on 2 cm space to wall, 5 cm space for hand, 19 cm rise height, 25 cm deck thickness, 200 cm headspace.

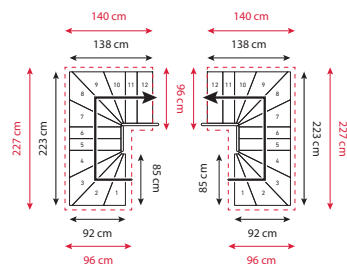
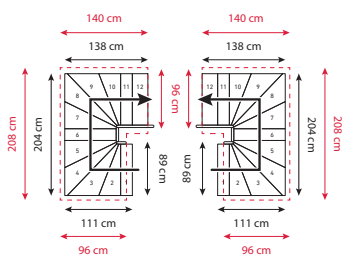
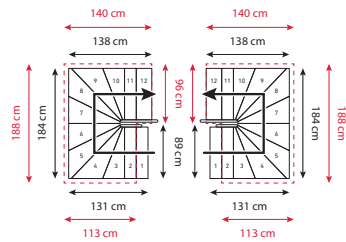
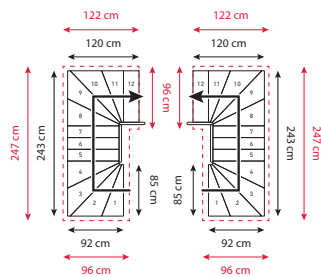
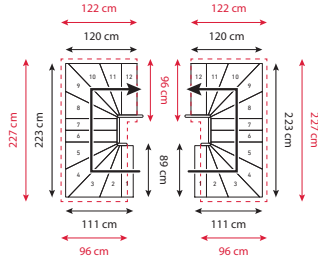
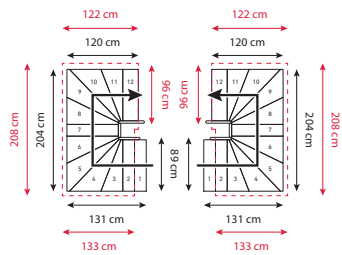
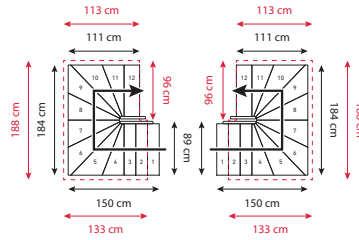
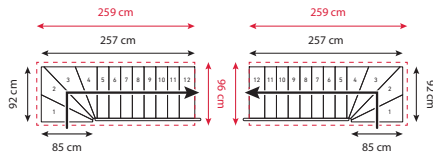

HAMBURG 12 TREADS - WIDTH 85 CM

H 240.5 - 279.5 cm

— Staircase dimensions incl. Classic/Style 6 banister on 1 side. See p. 5 for staircase width (C1) with Design banister.

- - Floor opening size is defined based on 2 cm space to wall, 5 cm space for hand, 19 cm rise height, 25 cm deck thickness, 200 cm headspace.

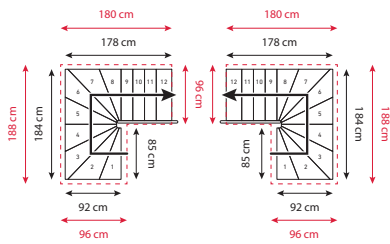
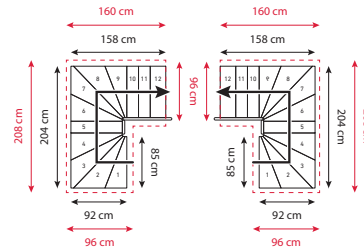
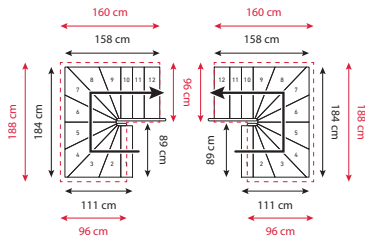

HAMBURG 13 TREADS - WIDTH 85 CM

H 259 - 301 cm

— Staircase dimensions incl. Classic/Style 6 banister on 1 side. See p. 5 for staircase width (C1) with Design banister.

- - Floor opening size is defined based on 2 cm space to wall, 5 cm space for hand, 19 cm rise height, 25 cm deck thickness, 200 cm headspace.

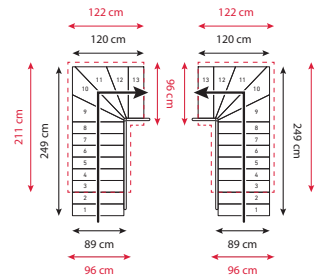
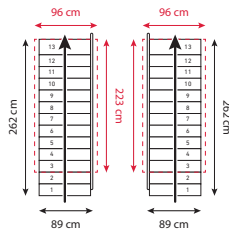

HAMBURG 13 TREADS - WIDTH 85 CM

H 259 - 301 cm

— Staircase dimensions incl. Classic/Style 6 banister on 1 side. See p. 5 for staircase width (C1) with Design banister.

- - - Floor opening size is defined based on 2 cm space to wall, 5 cm space for hand, 19 cm rise height, 25 cm deck thickness, 200 cm headspace.



HAMBURG 13 TREADS - WIDTH 85 CM

H 259 - 301 cm

— Staircase dimensions incl. Classic/Style 6 banister on 1 side. See p. 5 for staircase width (C1) with Design banister.

- - Floor opening size is defined based on 2 cm space to wall, 5 cm space for hand, 19 cm rise height, 25 cm deck thickness, 200 cm headspace.

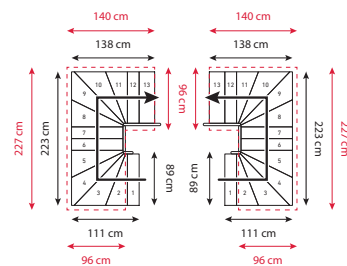
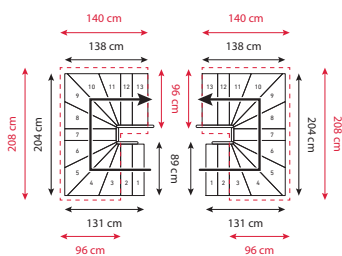
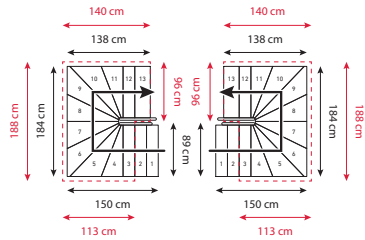
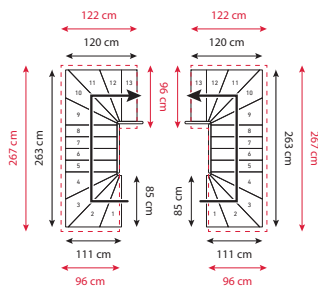
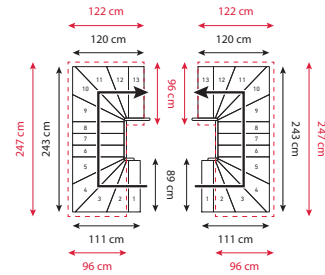
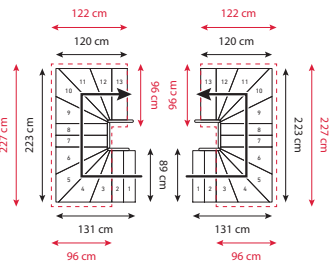
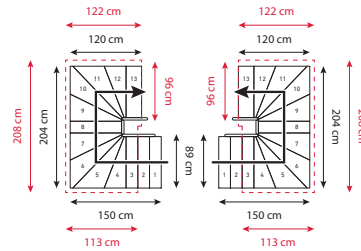
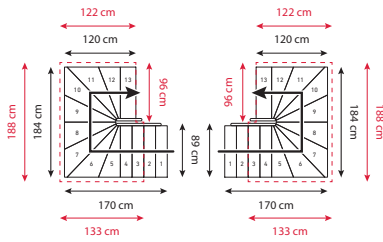

HAMBURG 13 TREADS - WIDTH 85 CM

H 259 - 301 cm

— Staircase dimensions incl. Classic/Style 6 banister on 1 side. See p. 5 for staircase width (C1) with Design banister.

- - - Floor opening size is defined based on 2 cm space to wall, 5 cm space for hand, 19 cm rise height, 25 cm deck thickness, 200 cm headspace.

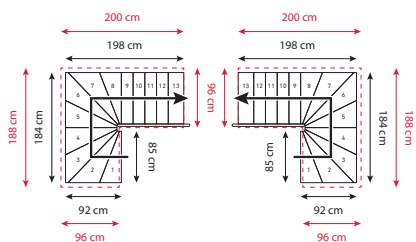
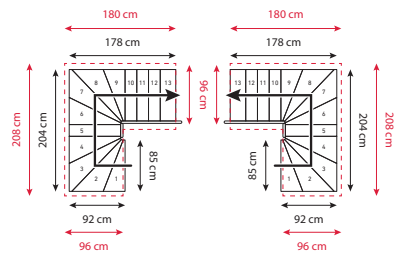
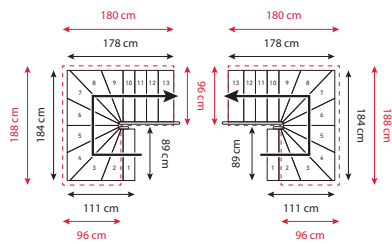
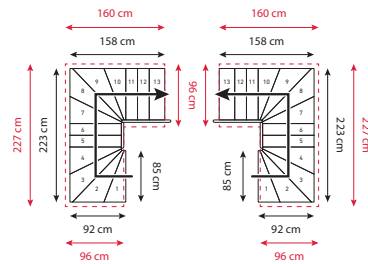
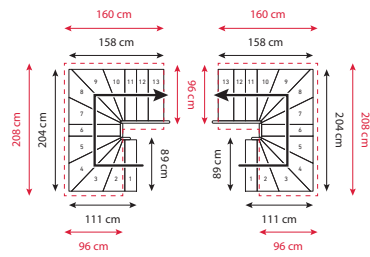
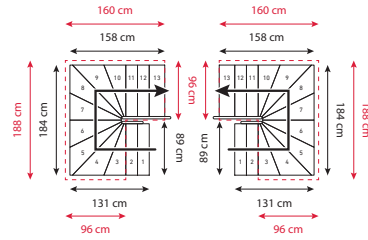
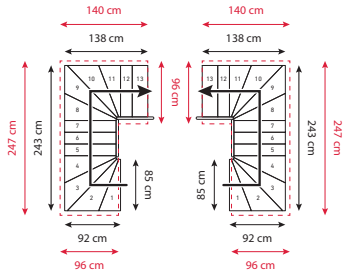

HAMBURG 14 TREADS - WIDTH 85 CM

H 277.5 - 322.5 cm

— Staircase dimensions incl. Classic/Style 6 banister on 1 side. See p. 5 for staircase width (C1) with Design banister.

--- Floor opening size is defined based on 2 cm space to wall, 5 cm space for hand, 19 cm rise height, 25 cm deck thickness, 200 cm headspace.

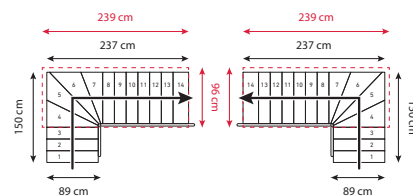
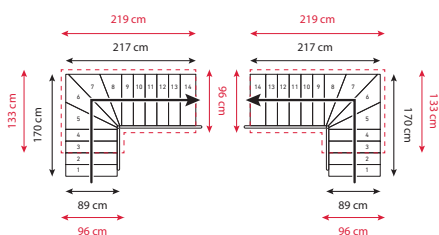
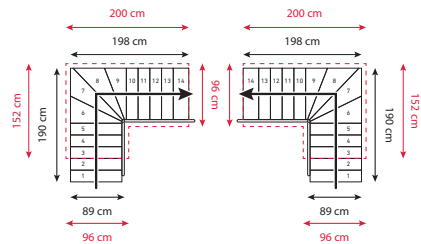
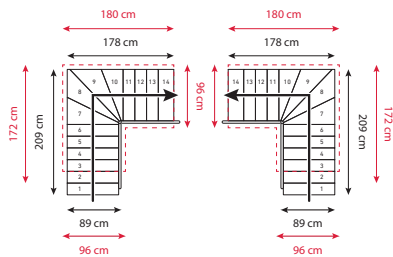
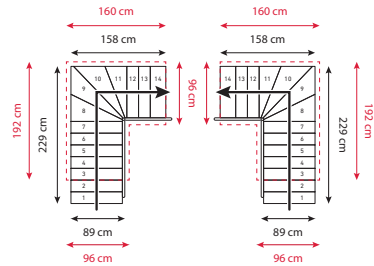
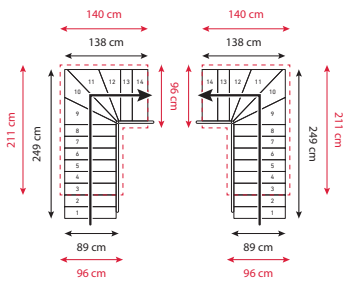
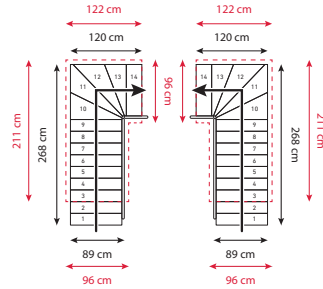
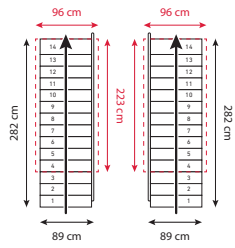

HAMBURG 14 TREADS - WIDTH 85 CM

H 277.5 - 322.5 cm

— Staircase dimensions incl. Classic/Style 6 banister on 1 side. See p. 5 for staircase width (C1) with Design banister.

--- Floor opening size is defined based on 2 cm space to wall, 5 cm space for hand, 19 cm rise height, 25 cm deck thickness, 200 cm headspace.

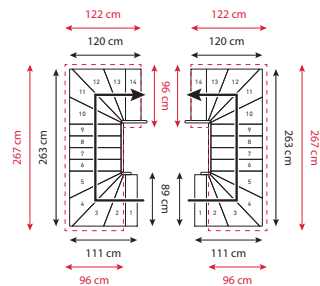
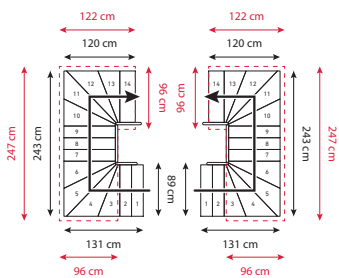
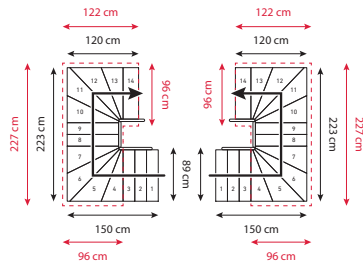
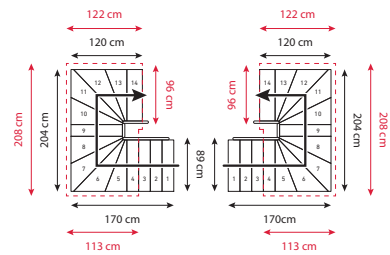
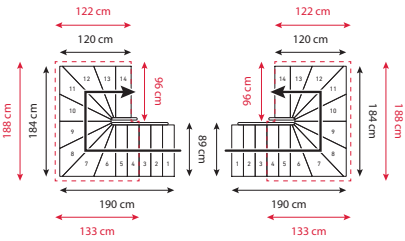
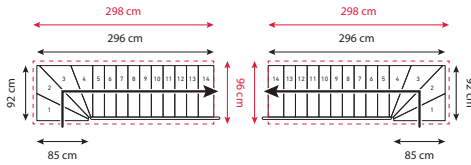
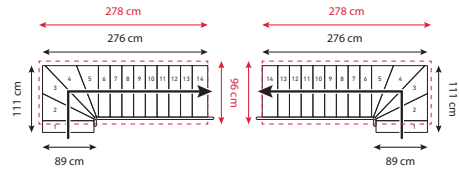
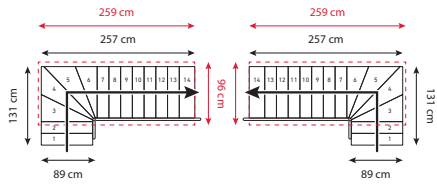

HAMBURG 14 TREADS - WIDTH 85 CM

H 277.5 - 322.5 cm

— Staircase dimensions incl. Classic/Style 6 banister on 1 side. See p. 5 for staircase width (C1) with Design banister.

--- Floor opening size is defined based on 2 cm space to wall, 5 cm space for hand, 19 cm rise height, 25 cm deck thickness, 200 cm headspace.

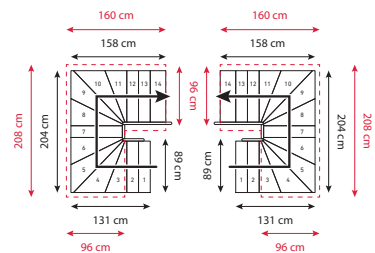
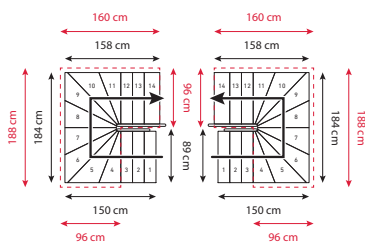
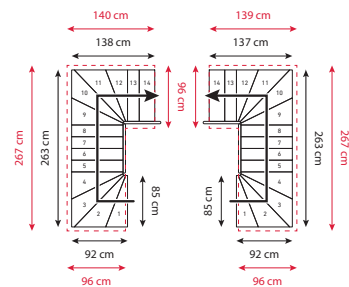
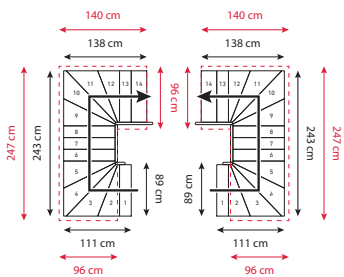
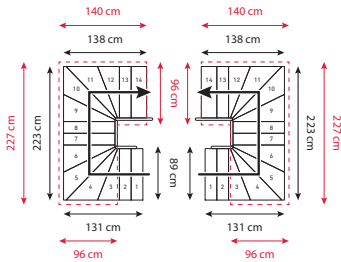
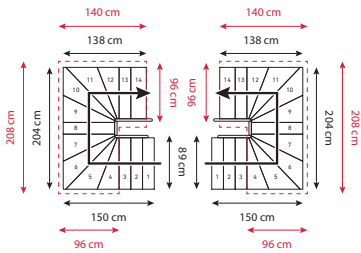
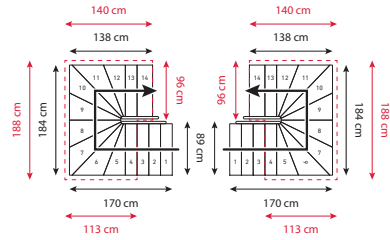
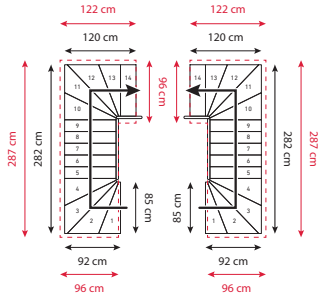

HAMBURG 14 TREADS - WIDTH 85 CM

H 277.5 - 322.5 cm

— Staircase dimensions incl. Classic/Style 6 banister on 1 side. See p. 5 for staircase width (C1) with Design banister.

--- Floor opening size is defined based on 2 cm space to wall, 5 cm space for hand, 19 cm rise height, 25 cm deck thickness, 200 cm headspace.

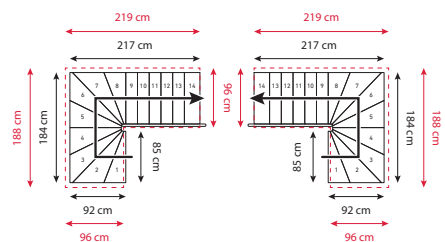
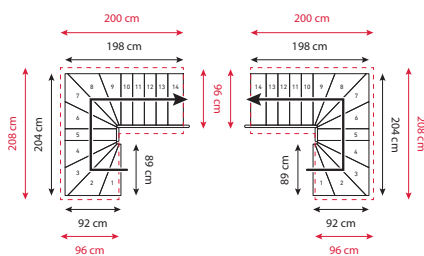
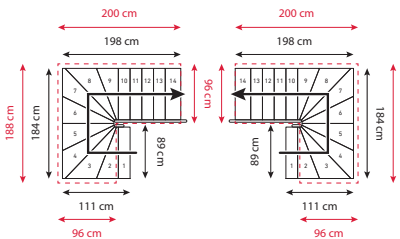
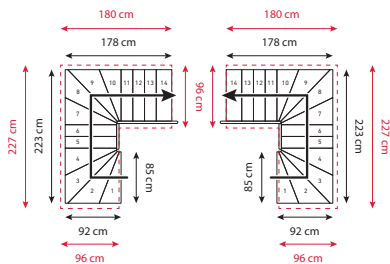
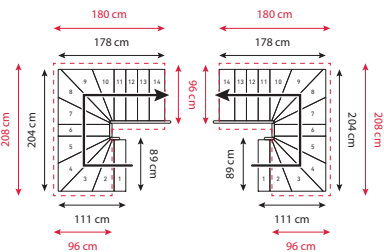
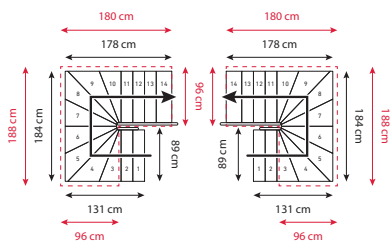
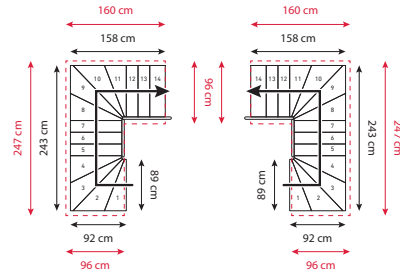
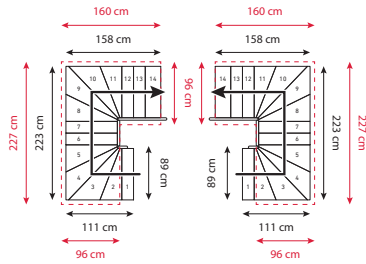

HAMBURG QUARTER TURN DIMENSIONS

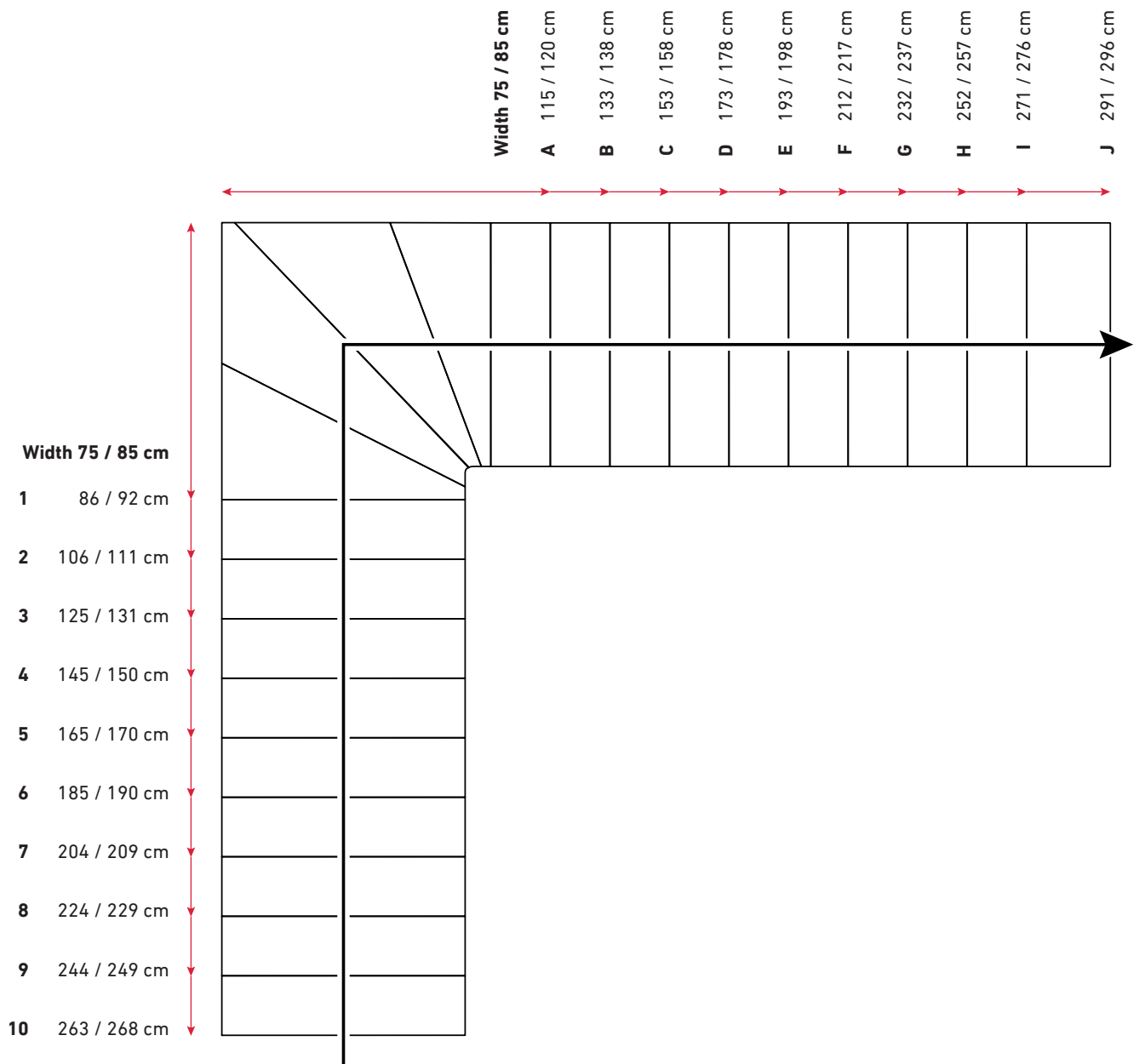

HAMBURG HALF TURN DIMENSIONS

